

SH C01

Economical Steel Articulating Monitor Arm

Fits Most 13"-32" LCD/LED Monitors



**Also Fits
Curved Monitors**

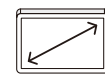
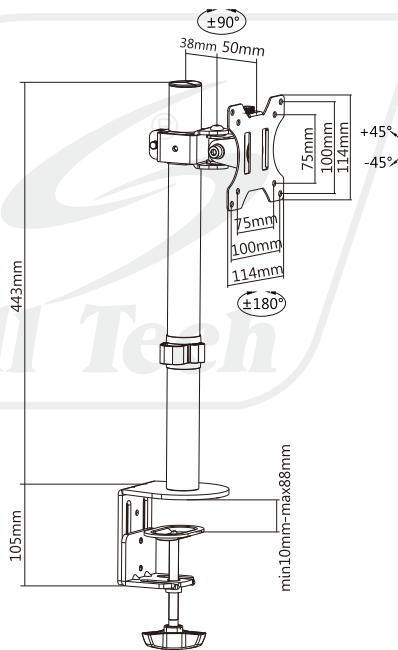

Screen Size
13"-32"



Weight Capacity
8kg/17.6lbs



Tilt Range
+45° ~ -45°

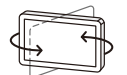

Swivel Range
+90° ~ -90°



Screen Rotation
360°

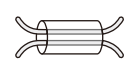

Cable
Management

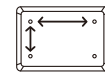

VESA Compatible
75x75 100x100

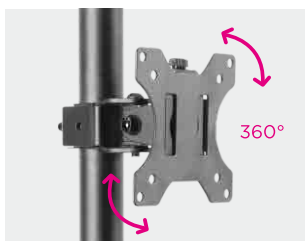

**Portrait and Landscape
Orientation.**

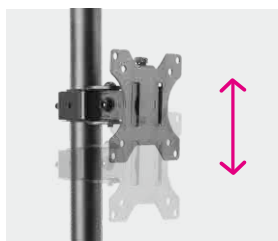

Vertical Height Adjustable
for an optimal viewing
experience.



**Clamp & Grommet Mounts
Included**
mounts to most any style
desktop.

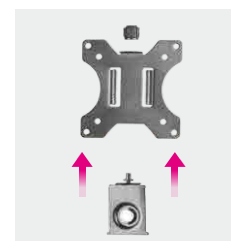

Detachable VESA Plate
enables easy installation.



Cable Management
for an organized and neat
workspace.